

MOBILE MANIPULATOR ROBOT (MMR)

RB-VOGUI

FOR **INDOOR** & **OUTDOOR**
MANIPULATION APPLICATIONS







VERSATILITY & **HIGH MOBILITY**

-  AGRICULTURE
-  CONSTRUCTION
-  LOGISTICS
-  RESEARCH & DEVELOPMENT





RB-VOGUI

RB-VOGUI+ is an Autonomous Mobile Manipulator designed for R&D applications in both indoor and outdoor environments, with a focus on agriculture, construction, and industrial sectors. It combines the RB-VOGUI all-terrain platform with Universal Robots e-Series arms (UR7e, UR8 Long or UR12e), providing a versatile, modular, and adaptable solution for handling, transport, or monitoring tasks across diverse environments.

 UP TO 130 KG OF PAYLOAD	 OUTDOOR ENVIRONMENTS	 OMNIDIRECTIONAL KINEMATICS
 UP TO 6 H. OF AUTONOMY	 REMOTE TURN ON/OFF	 SLAM / GPS NAVIGATION

ARM OPTIONS

 UR7e	 UR8 Long	 UR12e
---	---	--

INCLUDED COMPONENTS

- CPU i7
- Battery 48VDC@45Ah
- 5G Router
- IMU
- RGBD camera
- Safety Pack 360°
 - » 2D Safety LiDARs + Safety PLC
- [Charging Station](#)

OPTIONAL COMPONENTS

- GPS
- GPS + Base station GPS
- 3D LiDAR Robosense Airy
- 3D LiDAR Robosense RS-HELIOS 16P
- 3D SLAM Software Packages
- AI Computing Vision Package
 - » ZED camera and GPU
- OnRobot VGC10 gripper
- OnRobot RG6 gripper
- OnRobot RG2 gripper
- OnRobot 2FG7 gripper
- Robotiq 2F-85 gripper
- Robotiq 2F-140 gripper
- OnRobot Eyes gripper camera

Version	UR7e	UR8 Long	UR12e
Dimensions (mm)	1.044 x 776 x 742	1.044 x 776 x 742	1.044 x 776 x 742
Weight (kg)	185	210	200
Payload (kg)	130	105	115
Arm payload (kg)	7,5	10	12,5
Arm reach (mm)	850	1.750	1.300
Arm weight (kg)	20	45	35
Speed (m/s)	2,5	2,5	2,5
Environment	Indoor / Outdoor	Indoor / Outdoor	Indoor / Outdoor
Enclosure class	IP53 weatherproof	IP53 weatherproof	IP53 weatherproof
Autonomy (h)	6	6	6
Traction Motors (W)	4 x 500 with brake	4 x 500 with brake	4 x 500 with brake
Traction systems	Omnidirectional - Dual Ackerman	Omnidirectional - Dual Ackerman	Omnidirectional - Dual Ackerman
Localization system	SLAM	SLAM	SLAM
Temperature range (°C)	-10° to +45°	-10° to +45°	-10° to +45°
Max. Slope (%)	47	47	47
Controller	ROS 2 Architecture	ROS 2 Architecture	ROS 2 Architecture
WiFi	WiFi 802.11 b/g/n/ac	WiFi 802.11 b/g/n/ac	WiFi 802.11 b/g/n/ac
Bluetooth	4.0	4.0	4.0
Connectivity	USB, Ethernet, HDMI	USB, Ethernet, HDMI	USB, Ethernet, HDMI
Power outputs	12 V, 24 V, VBATT	12 V, 24 V, VBATT	12 V, 24 V, VBATT

RB-VOGUI

UR7e

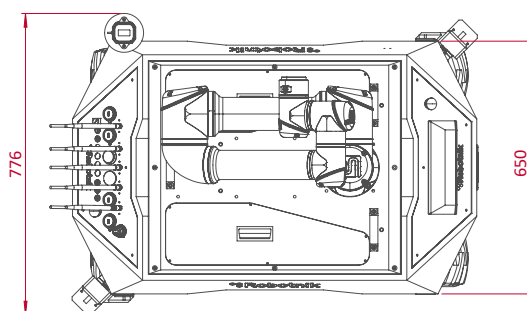
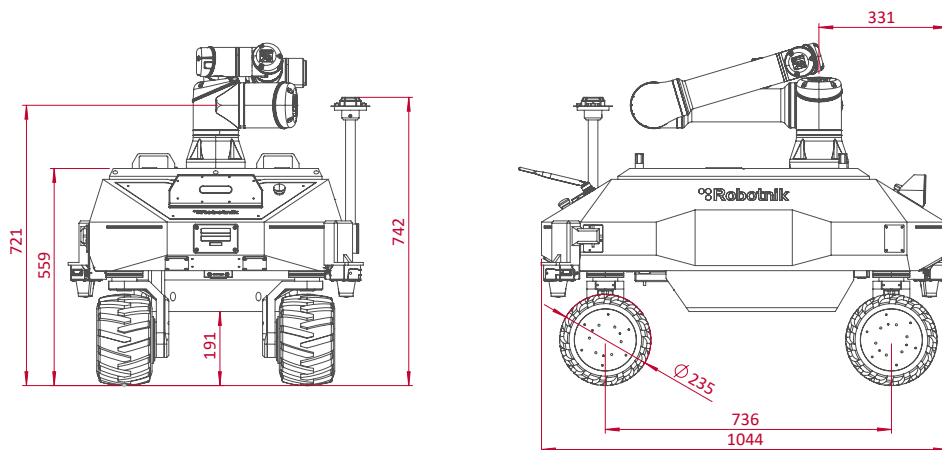

RB-VOGUI

UR12e

